

SI Screens

2009 New Product Development Line-up



Why SI?

SI is a technology based U.S. projector screen manufacturer focused on delivering "state-of-the-art" performance. Each motorized, fixed, and curved projector screen we produce meets exceedingly tight tolerances and must deliver all the stunning HD visuals we require.

Our mission is to develop the most advanced projector screens that effectively address evolving consumer demands for performance, value, and visual appeal—each strategically aligned with today's demanding high definition HD projector screen trends.



Black Diamond Darkroom Immersion

Black Diamond dramatically reduces light scatter, increasing viewer “immersion” and contrast by minimizing the room washout that exist with standard front projection screens therefore eliminating the need for masking.



Black Diamond Contrast Enhancement

Black Diamond increases contrast by over 300% with all projector types in all environments.



Black Diamond Bright Room Versatility

Black Diamond allows front projection to exist in game rooms, family rooms, and even outdoor applications.

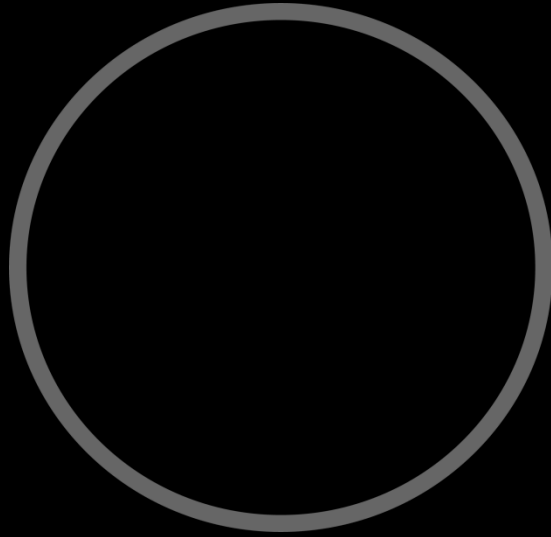

Black Diamond II HD .8 Gain

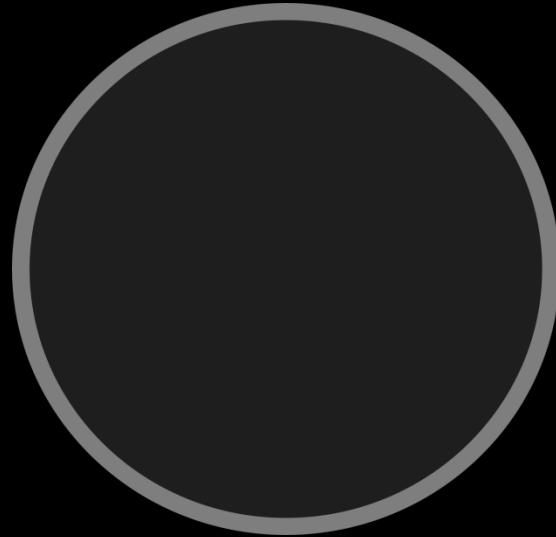

Black Diamond II HD 1.4 Gain

Introducing Black Diamond II

Black Diamond II is available in both a 1.4 and .8 gains to maximize projector performance in all environments.

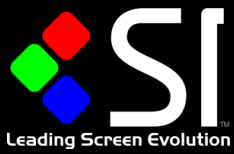

LIGHTS OFF

LIGHTS ON



Black Diamond II Benefits

- Both 1.4 & .8 Gains
- Greater color accuracy
- Amplified contrast
- Enhanced uniformity

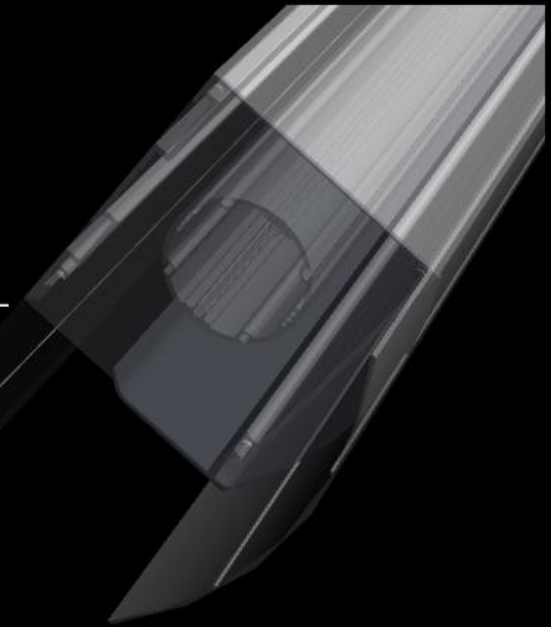
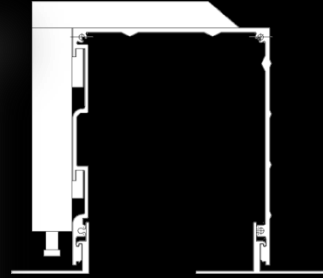
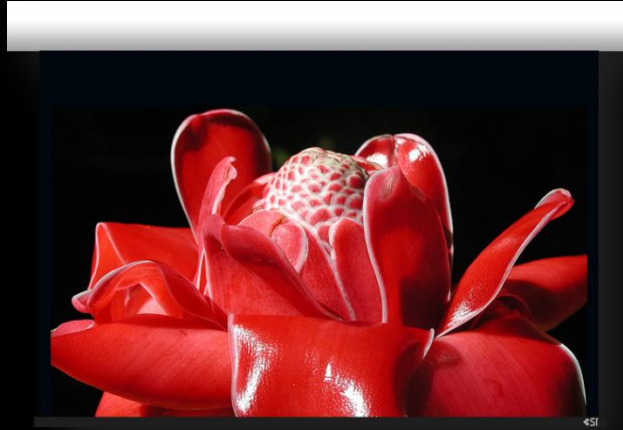

Reference Motorized

- The first flush & decor motorized projector screen
- The most flexible controls available
- The first low voltage projector screen

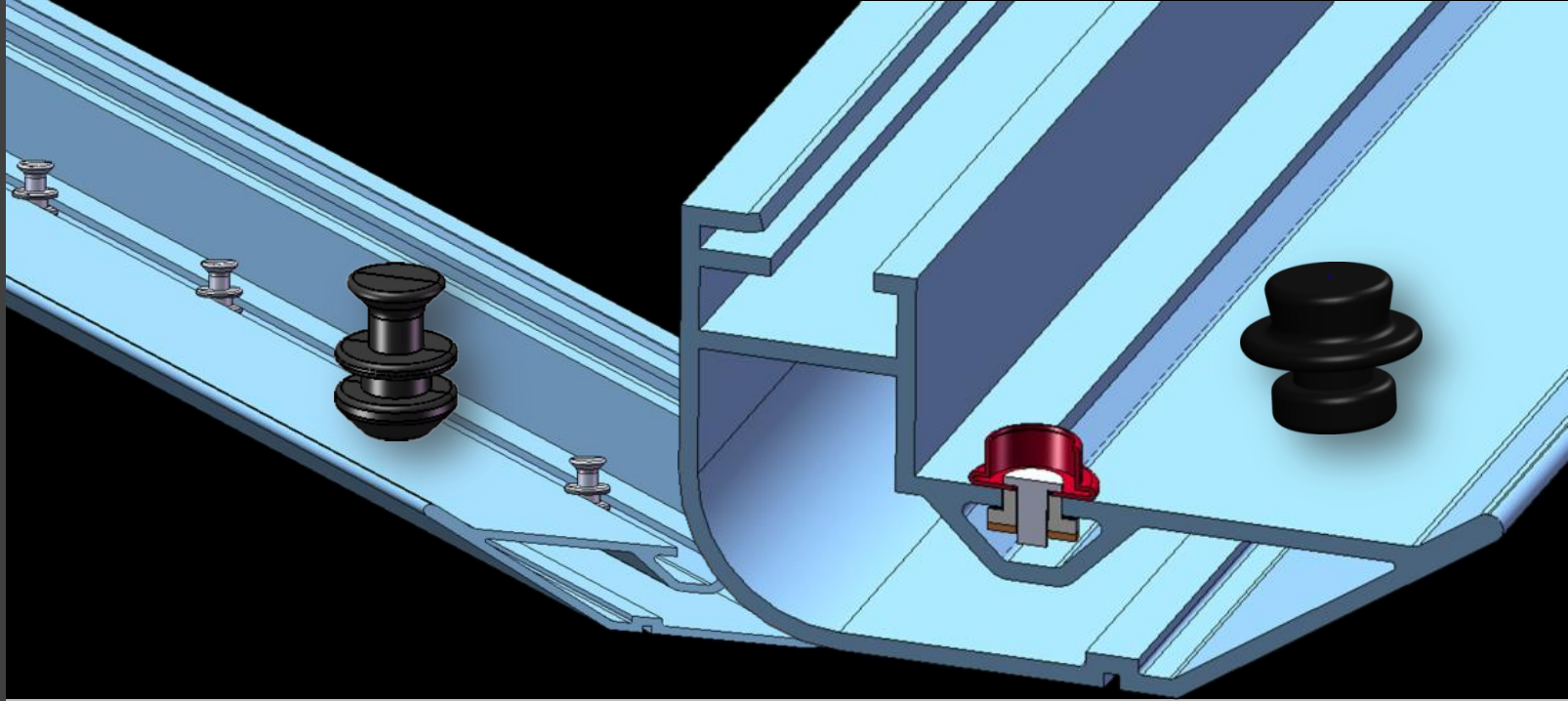

New Attachments

- “installs in 15 minutes or less”
- Snap system for vinyl HD materials
- Bungee system for Weave and Black Diamond HD



Reference CURVE

- Widens viewing angle up to 30%
- Streamline mounting system for elegant décor

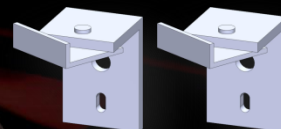

Standard Emboss Pattern

SI's **HD** Emboss Pattern

HD Screen Materials

- Improved satin emboss patterns to maximize 1080P
- Future compliant with 2K x 4K resolutions

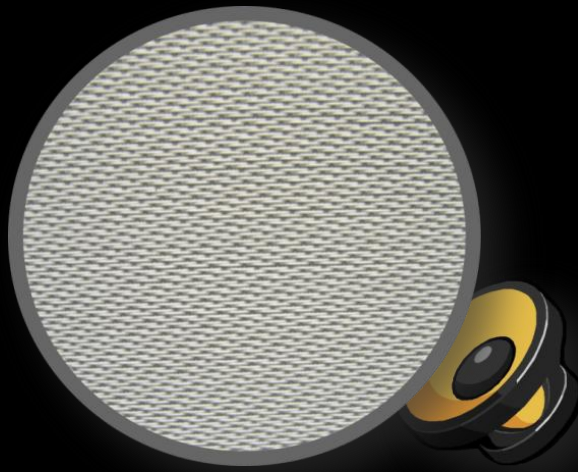

Lunar Maestro HD

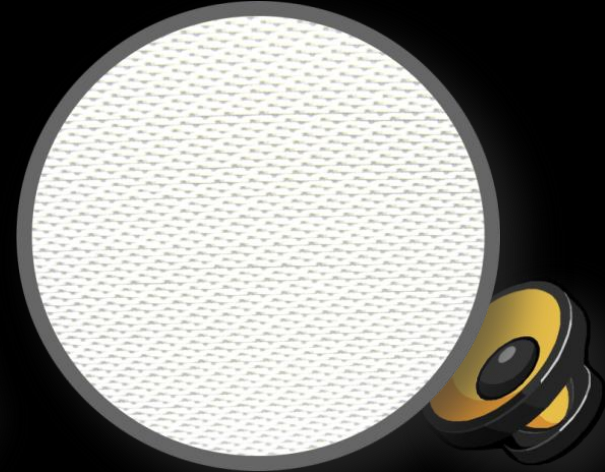

Gamma Maestro HD

Maestro Weaves

- Sizes available up to 205" diagonal
- Acoustic characteristics provide industry leading audio clarity with a maximum measured variance of +2 -1 db from 20 to 20k Hz. Micro Perf is -7db or more.

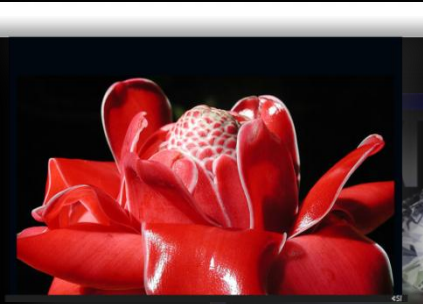

Reference Series
Fixed & Motorized



Performance Series
Fixed & Motorized



Sensation
Fixed & Portable

Good – Better – Best

We believe all customers deserve to own a SI projection screen. We offer the best performing and highest quality product at all price points.

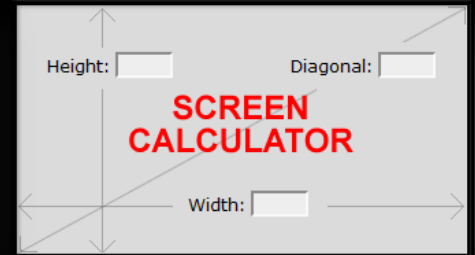

SI Tools

The days of educated guessing are now a thing of the past. SI has created the simplest way for an end user or professional AV installer to maximize picture quality by selecting the best screen surface for their projector, screen size, and light environment to get a SMTPE standard picture.

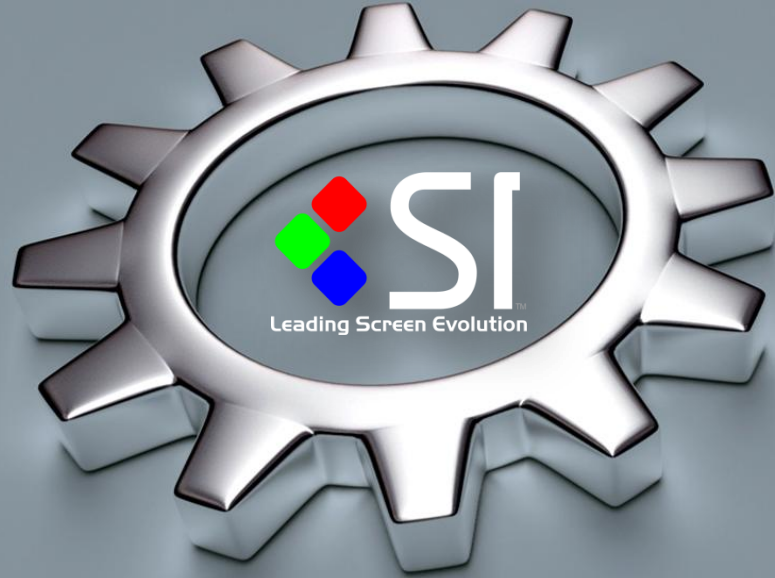

Come join in the SI experience...

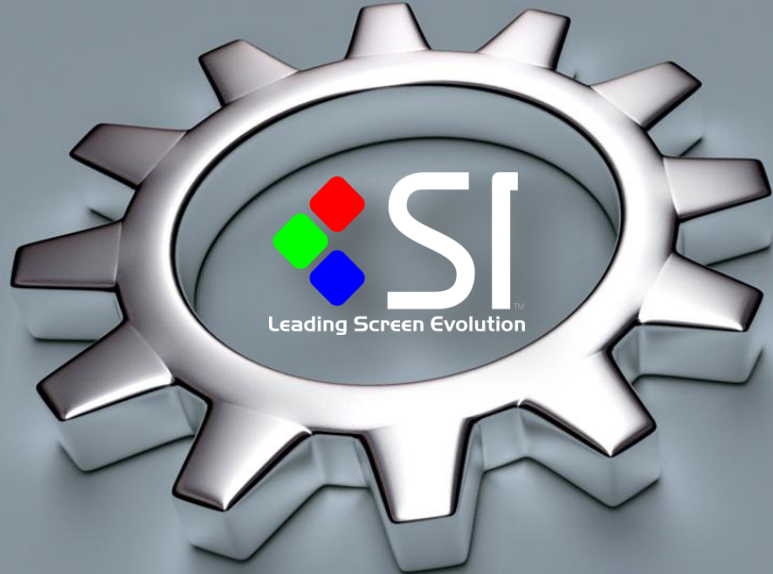

Contact Information (512) 832 - 6939

• www.siscreens.com | sales@siscreens.com

• 11110 Metric Blvd Suite D

• Austin TX 78758